

# LOW JITTER PIN CONFIGURABLE DUAL LVPECL OUTPUT ULTRA MINIATURE PURE SILICON™ CLOCK OSCILLATOR

ASEMDLP

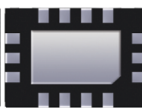

3.2 x 2.5 x 0.85 mm

**ASEMDLP**



RoHS/RoHS II compliant

## Moisture Sensitivity Level – MSL 1

### FEATURES:

- Ultra Miniature Pure Silicon™ Clock Oscillator
- Pin Configurable LVPECL Dual output
- Low Jitter (Period Jitter RMS 3ps typical)
- Low Integrated Phase Jitter 2ps max
- Excellent Shock & Vibration Immunity

### APPLICATIONS:

- Consumer Electronics
- Storage Area Networks
- SATA, SAS, Fibre Channel
- Passive Optical Networks
- EPON, 10G-EPON, GPON, 10G-PON
- Ethernet
- 1G, 10GBASE-T/KR/LR/SR, and FCoE
- PCI Express

Low Jitter  
Pin Configurable  
LVPECL Dual Output  
3G MEMS

### STANDARD SPECIFICATIONS:

#### Pre-programmed Output Frequency Configuration

Ordering Info	Freq (MHz)	Freq Select Bits [FS2, FS1, FS0] – Default is [111]							
		000	001	010	011	100	101	110	<b>111</b>
Frequency Configuration 1	f <sub>OUT1</sub>	106.25	100	125	156.25	156.25	156.25	125	<b>400</b>
	f <sub>OUT2</sub>	25	100	125	156.25	25	125	25	<b>200</b>
Custom Configuration	f <sub>OUT1</sub>	Contact Abracon for customized configurations							
	f <sub>OUT2</sub>								

Frequency select bits [FS2, FS1, FS0] are weakly tied high so if left **floated**, the default setting will be [111] and the device will output the associated frequency highlighted in **Bold**. If other frequency combinations are required, please contact Abracon for customized configuration. Please see the configurable frequency range in the section 2.0

#### Key Electrical Specifications

Parameters	Minimum	Typical	Maximum	Units	Notes
Configurable frequency range	10	-----	460	MHz	Commercial, Industrial temp range
Operating Temperature	-20	-----	+70	°C	See options
Storage Temperature	-55	-----	+150	°C	
Overall Frequency Stability*1	-50	-----	+50	ppm	See options
Supply Voltage (V <sub>dd</sub> )	+2.25	-----	+3.6	V	
Startup Time	-----	-----	5	ms	
Enable Time	-----	-----	20	ns	
Disable Time	-----	-----	5	ns	
Disable Current	-----	21	23	mA	
Tri-state Function (Standby/Disable)	"1" (VIH≥0.75*V <sub>dd</sub> ) or Open: Oscillation "0" (VIL<0.25*V <sub>dd</sub> ) : Hi Z			V	40kΩ pull-up resistor embedded
Aging	-5.0	-----	+5.0	ppm	First year
Supply Current (I <sub>dd</sub> )	-----	89	-----	mA	RL=50Ω, 156.25MHz
Output Logic Level	V <sub>OH</sub>	V <sub>dd</sub> -1.08	-----	V	RL=50 Ω
	V <sub>OL</sub>	-----	V <sub>dd</sub> -1.55		
Peak to Peak Output Swing	-----	800	-----	mV	Single-Ended
Rise Time	-----	250	-----	ps	RL=50 Ω, CL=2pF
Fall Time	-----	250	-----	ps	20% to 80%
Duty Cycle	48	-----	52	%	Differential

\*1. Frequency stability includes frequency variations due to initial tolerance, temp. and power supply voltage

ABRACON IS  
ISO9001:2008  
CERTIFIED



**ABRACON**  
CORPORATION

Visit [www.abracon.com](http://www.abracon.com) for Terms & Conditions of Sale **Revised: 11.05.14**  
30332 Esperanza, Rancho Santa Margarita, California 92688  
tel 949-546-8000 | fax 949-546-8001 | [www.abracon.com](http://www.abracon.com)

# LOW JITTER PIN CONFIGURABLE DUAL LVPECL OUTPUT ULTRA MINIATURE PURE SILICON™ CLOCK OSCILLATOR

ASEMDLP

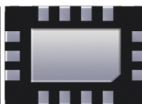

3.2 x 2.5 x 0.85 mm

ASEMDLP



RoHS/RoHS II compliant

## Key Electrical Specifications (continued)

Parameters	Minimum	Typical	Maximum	Units	Notes
Period Jitter RMS ( $J_{PER}$ )	-----	2.5	-----	ps	F01=F02= 156.25MHz
Integrated Phase Jitter ( $J_{PH}$ )	-----	0.25	2	ps	200kHz ~ 20MHz, 156.25MHz
	-----	0.38	2		100kHz ~ 20MHz, 156.25MHz
	-----	1.70	2		12kHz ~ 20MHz, 156.25MHz

## PHASE JITTER

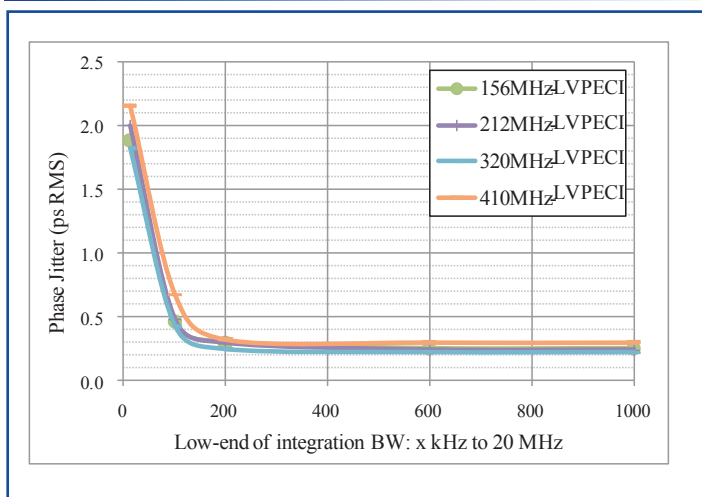

## ABSOLUTE MAXIMUM RATINGS

Item	Minimum	Maximum	Unit	Condition
Supply Voltage	-0.3	+4.0	V	
Input Voltage	-0.3	$V_{dd}+0.3$	V	
Junction Temp.	-----	+150	°C	
Storage Temp.	-55	+150	°C	
Soldering Temp.	-----	+260	°C	40sec max
ESD			V	
HBM		4,000		
MM		400		
CDM		1,500		

## OPTIONS AND PART IDENTIFICATION:

(left blank if standard)

ASEMDLP -  -  -

Operating Temp.
Blank: -20°C ~ +70°C
L: -40°C ~ +85°C

Overall Freq. Stability
Blank: ±50ppm
R: ±25 ppm

Packaging
Blank: Tube (110pcs / Tube)
T: Tape & Reel (1kpcs / reel)
T3: Tape & Reel (3kpcs / reel)
T5: Tape & Reel (5kpcs / reel)

Frequency Combination	Freq (MHz)	Freq Select Bits [FS2, FS1, FS0] – Default is [111]							
		000	001	010	011	100	101	110	111
Standard Configuration	$f_{OUT1}$	106.25	100	125	156.25	156.25	156.25	125	400
	$f_{OUT2}$	25	100	125	156.25	25	125	25	200
Custom Configuration	$f_{OUT1}$	Contact Abracon for customized configurations							
	$f_{OUT2}$								

Default condition: Frequency select bits [FS2, FS1, FS0] are all left floated. FS2, FS1, FS0 are pulled high [111]  
Frequency combination and default frequency is customized upon request. Please contact Abracon for the frequency combinations.

ABRACON IS  
ISO9001:2008  
CERTIFIED



Visit [www.abracon.com](http://www.abracon.com) for Terms & Conditions of Sale **Revised: 11.05.14**  
30332 Esperanza, Rancho Santa Margarita, California 92688  
tel 949-546-8000 | fax 949-546-8001 | [www.abracon.com](http://www.abracon.com)

# LOW JITTER PIN CONFIGURABLE DUAL LVPECL OUTPUT ULTRA MINIATURE PURE SILICON™ CLOCK OSCILLATOR

ASEMDLP

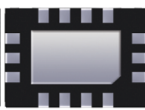

ASEMDLP



RoHS/RoHS II compliant

3.2 x 2.5 x 0.85 mm

## MECHANICAL DIMENSIONS

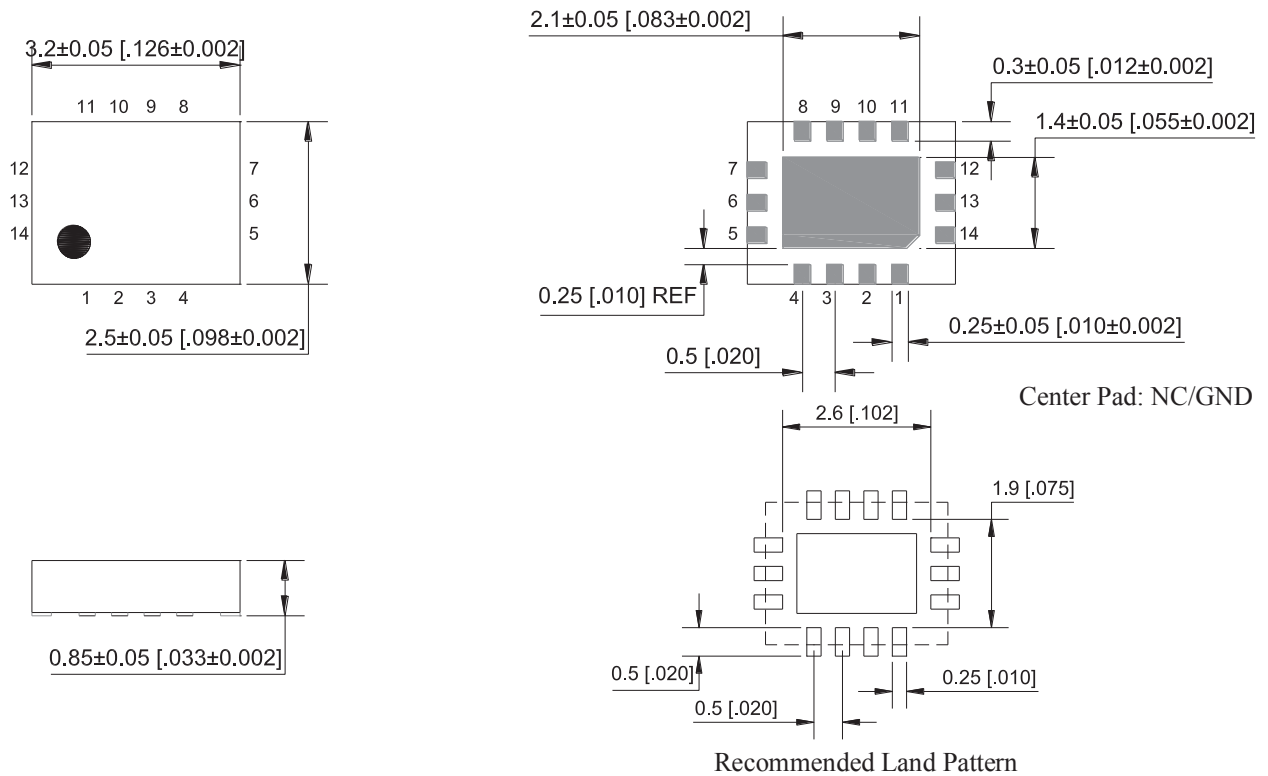

Pin No.	Pin Name	Pin Type	Description
1	Enable	I	Enables outputs when high and disables (tri-state) them when low
2	NC	NA	Leave unconnected or grounded
3	NC	NA	Leave unconnected or grounded
4	GND	Power	Ground
5	FS0	I	Least significant bit for frequency selection
6	FS1	I	Middle bit for frequency selection
7	FS2	I	Most significant bit for frequency selection
8	Output1+	O	Positive LVPECL Output 1
9	Output1-	O	Negative LVPECL Output 1
10	Output 2-	O	Negative LVPECL Output 2
11	Output 2+	O	Positive LVPECL Output 2
12	VDD2	Power	Power Supply 2 for LVPECL Output 2
13	VDD	Power	Power Supply
14	NC	NA	Leave unconnected or grounded

Dimensions: mm (inches)

# LOW JITTER PIN CONFIGURABLE DUAL LVPECL OUTPUT ULTRA MINIATURE PURE SILICON™ CLOCK OSCILLATOR

ASEMDLP

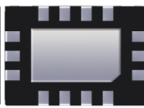

3.2 x 2.5 x 0.85 mm

ASEMDLP



RoHS/RoHS II compliant

## REFLOW PROFILE

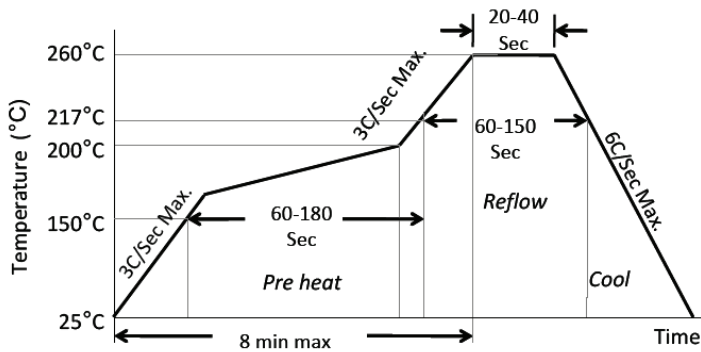

Ramp-Up Rate (200°C to Peak Temp)	3°C/Sec Max.
Preheat Time 150°C to 200°C	60-180 Sec
Time maintained above 217°C	60-150 Sec
Peak Temperature	255-260°C
Time within 5°C of actual Peak	20-40 Sec
Ramp-Down Rate	6°C/Sec Max.
Time 25°C to Peak Temperature	8 min Max.

## TAPE & REEL:

T= 1,000pcs/reel (D=180mm)  
T3= 3,000pcs/reel (D=180mm)  
T5= 5,000pcs/reel (D=330mm)

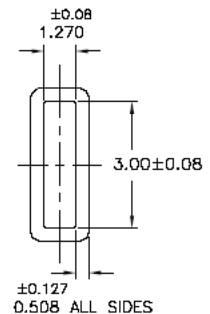
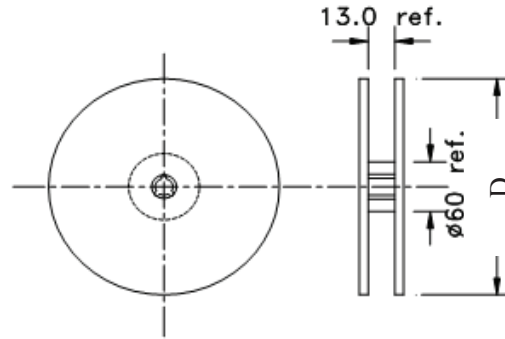
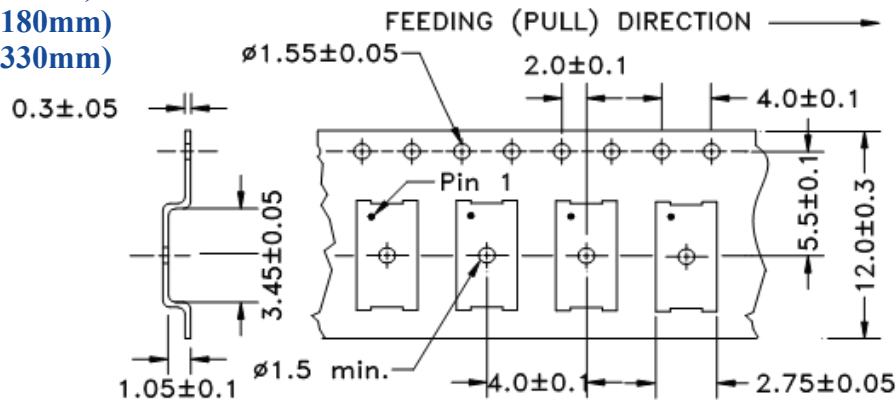

Tube: 110 pcs/tube

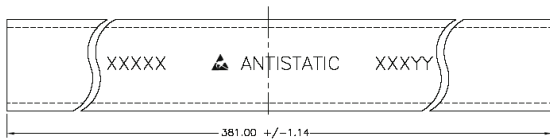

Unit orientation in tube:



Dimensions: mm

**ATTENTION:** Abracon Corporation's products are COTS – Commercial-Off-The-Shelf products; suitable for Commercial, Industrial and, where designated, Automotive Applications. Abracon's products are not specifically designed for Military, Aviation, Aerospace, Life-dependant Medical applications or any application requiring high reliability where component failure could result in loss of life and/or property. For applications requiring high reliability and/or presenting an extreme operating environment, written consent and authorization from Abracon Corporation is required. Please contact Abracon Corporation for more information.

ABRACON IS  
ISO9001:2008  
CERTIFIED



**ABRACON  
CORPORATION**

Visit [www.abracon.com](http://www.abracon.com) for Terms & Conditions of Sale **Revised: 11.05.14**  
30332 Esperanza, Rancho Santa Margarita, California 92688  
tel 949-546-8000 | fax 949-546-8001 | [www.abracon.com](http://www.abracon.com)